

Rubber Pads

• MPT

MPT pads are cross-ribs profiled between upper and lower surfaces and are widely engaged to isolate noise and vibration of various applications, notably HVAC equipment. MPT pads are easily cut into various sizes to suit mounting brackets or bases.

Five (5) sizes of MPT pads are available:

Dimension Unit: mm				Compression Loading			
Model	Thickness	Width	Length	Recom'd Kg/cm ²	Max Kg/cm ²	Recom'd PSI	Max PSI
MPT-5	5	300	600	1.8	2.5	26	35
MPT-7	7	300	600	2.0	3.0	28	43
MPT-9	9	300	600	3.0	4.0	43	57
MPT-13	13	300	600	3.5	5.0	50	71
MPT-19	19	300	600	4.0	6.0	57	85

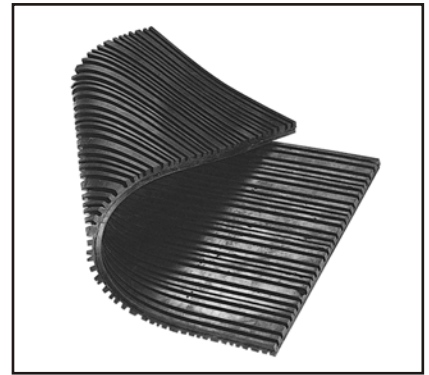

Stacking for more deflection

MPT pads may be stacked to increase deflection for better noise and vibration reduction while shimmed with 1.6mm thick steel plate(s) for better rigidity.

(Example: if 3 layers of pads are stacked thus offering 3 times the deflection of a single layer under the same load).

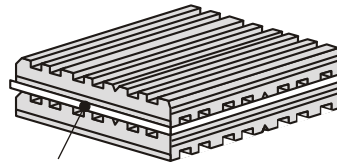

STEEL SHIM

STEEL SHIM



MACHINE BASE

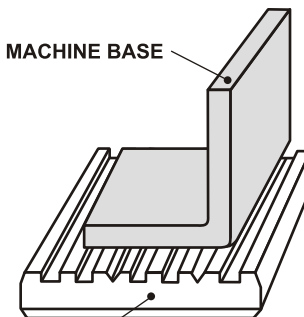

MPT PAD

MODE M1

Material

MPT pads are durable, easily applicable and cost saving general purpose isolation media. Standard stock is natural rubber though other elastomers are also available as options.

Application

Three (3) modes of applications following are means to spread out high density loads;

(1) Mode M1: where no bolting is necessary.

- Used where the machine base is resting freely onto the surface of MPT Pads.
- Steel shim may be required when necessary.

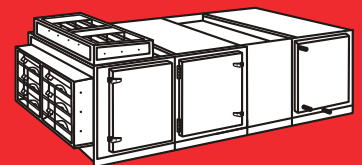
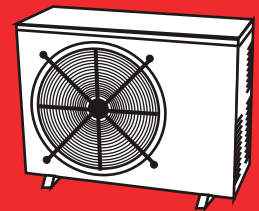
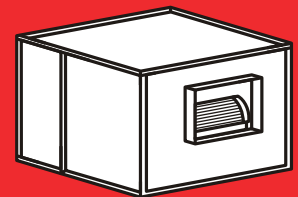

Rubber Pads

• MPT

(2) Mode M2 : where bolting is required for the machine base.

- A 20mm diameter hole is drilled through the MPT Pad and a thick gauge metal plate bonded on top.
- A rubber isolation sleeve is supplied for the prevention of vibration “bridging” between machine base and slab.

(3) Mode M3 : where level adjustment is required.

- Leveling bolts are usually already supplied with the machine.
- The steel plate is thick (minimum 6 mm recommended) and with a counterbored hole in the center to position the leveling bolt.

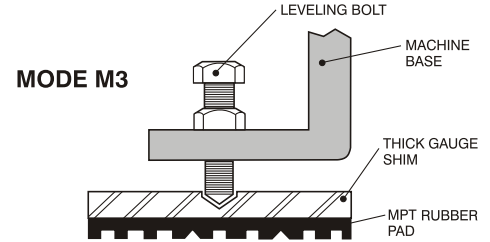
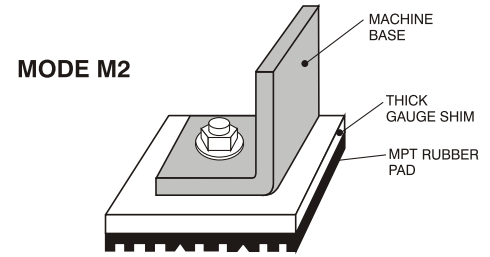

Table 1

Model and Load Size ^{*(3)}	Rated Load (Kgs) ^{*(1)}	MPT Pads Cut Size W x L (mm)	Pad Mounting Height per mode (mm)		
			M1	M2 ^{*(2)}	M3 ^{*(2)}
MPT-C - 90	90	50 x 50	9 or 13	12, 16	15, 19
MPT-C - 200	200	75 x 75	9 or 13	12, 16	15, 19
MPT-C - 350	350	100 x 100	9 or 13	12, 16	15, 19
MPT-C - 550	550	125 x 125	13 or 19	18, 24	19, 25
MPT-C - 780	780	150 x 150	13 or 19	18, 25	19, 25
MPT-C-1050	1050	150 x 200	13 or 19	18, 26	19, 25
MPT-C-1875	1875	150 x 250	19	25	25
MPT-C-2000	2000	200 x 200	19	25	25
MPT-C-2500	2500	200 x 250	19	25	25
MPT-C-3000	3000	200 x 300	19	25	25
MPT-C-3125	3125	250 x 250	19	25	25
MPT-C-4500	4500	300 x 300	19	25	25

*Note: (1) Loadings are based on 50 (+/-5) durometer MPT pads at 3.0kg/cm² (43 Psi) for MPT - 9, 4.0kg/cm² (57 Psi) for MPT -13 and 5.0kg/cm² (71 Psi) for MPT -19.

(2) The figures denote MPT pad engaged per mode M2 or M3 the thickness of which corresponds with those in M1 column.

(3) Ordering example: A machine base is 300kg load & rest on MPT Pads per mode M2. - From Table 1. MPT cut size will be (100 x 100)mm & MPT-13 is selected for instance. To order: MPT-C-350, M2 - 13

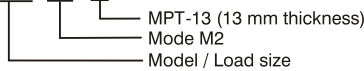

LOAD DEFLECTION CURVE MPT-9

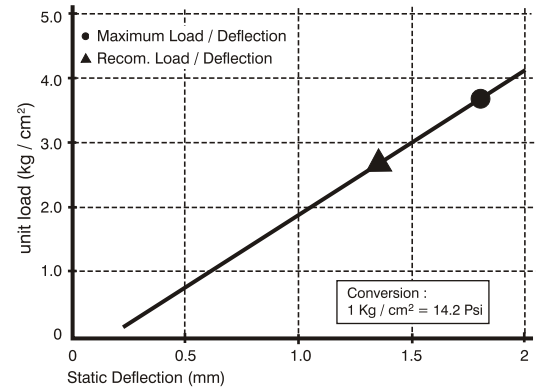

LOAD DEFLECTION CURVE MPT-5

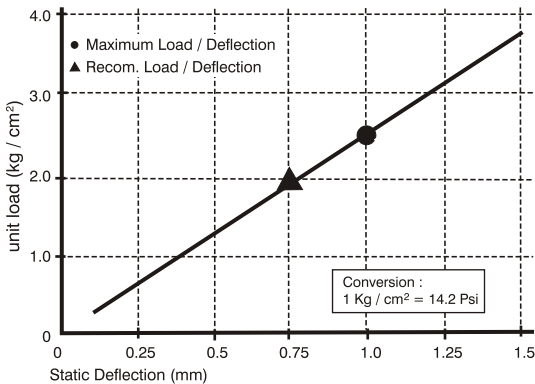

LOAD DEFLECTION CURVE MPT-13

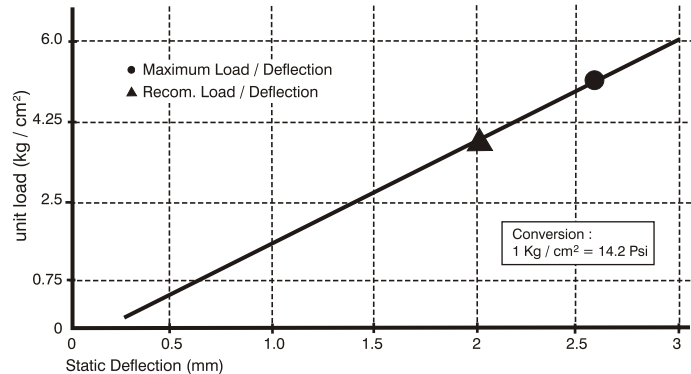

LOAD DEFLECTION CURVE MPT-7

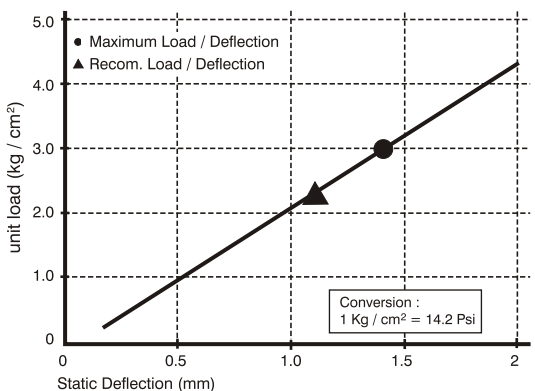

LOAD DEFLECTION CURVE MPT-19

